

SHENZHEN TIBTRONIX TECHNOLOGY CO., LTD.



TSBLXG80D-5749

10Gb/s 80km BiDi SFP+ Transceiver
Hot Pluggable, Single LC, +3.3V, 1490nm/1570nm CWDM DFB&APD, DDM

2013/6/1



Shenzhen Tibtronix Technology Co., Ltd.

3/F, 12th Building, Nangang 1st Industrial Park, Baimang Xili, Songbai Road, Nanshan District, Shenzhen, China

Tel: +86 755 23316583

Fax: +86 755 83129773

E-mail: sales@tibtronix.com

<http://www.tibtronix.com>

Features:

- ✧ Supports 9.95Gb/s to 11.3Gb/s bit rates
- ✧ Hot-pluggable SFP+ footprint
- ✧ Single LC for Bi-directional Transmission
- ✧ Maximum link length of 80km
- ✧ Built-in 1490/1570 WDM Filter
- ✧ Uncooled 1490nm or 1570nm CWDM DFB Laser.
- ✧ Power dissipation <1.5W
- ✧ No Reference Clock required
- ✧ Built-in digital diagnostic functions
- ✧ Temperature range 0°C to 70°C
- ✧ Very low EMI and excellent ESD protection
- ✧ RoHS Compliant Part

Applications:

- ✧ 10GBASE-ZR/ Ethernet
- ✧ SONET OC-192 / SDH
- ✧ 10G Fibre Channel

Description:

TIBTRONIX' TSBLXG80D-5749 Bi-directional 10Gb/s (SFP+) transceivers are compliant with the current SFP+ Multi-Source Agreement (MSA) Specification. They comply with 10GBASE-ZR Ethernet, SONET OC-192 / SDH and 10G Fibre Channel 1200-SM-LL-L. Digital diagnostics functions are available via a 2-wire serial interface, as specified in the SFP+ MSA.

● Absolute Maximum Ratings

Parameter	Symbol	Min.	Typical	Max.	Unit
Storage Temperature	T_S	-40		+85	°C
Supply Voltage	$V_{CC,T,R}$	-0.5		4	V
Relative Humidity	RH	0		85	%

● Recommended Operating Environment:

Parameter	Symbol	Min.	Typical	Max.	Unit
Case operating Temperature	T_C	-5		+70	°C
Supply Voltage	$V_{CC,T,R}$	+3.135		+3.465	V
Supply Current	I_{CC}			450	mA
Power Dissipation	P_D			1.5	W

● Electrical Characteristics ($T_{OP} = 0$ to 70 °C, $V_{CC} = 3.135$ to 3.465 Volts)

Parameter	Symbol	Min	Typ	Max	Unit	Note	
Transmitter:							
Differential input voltage swing		180		700	mVpp	1	
Transmit Disable Input	H	V_{IH}	2.0		$V_{CC}+0.3$	V	
	L	V_{IL}	0		0.8	V	
Transmit Enable Output	H	V_{OH}	2.4		$V_{CC}+0.3$	V	
	L	V_{OL}	0		0.4	V	2
Input Differential Impedance	Z_{in}	80	100	120	Ω		
Receiver							
Differential output voltage swing		300		850	mVpp	3	
LOS Output	H	V_{OH}	2.4		$V_{CC}+0.3$	V	2
	L	V_{OL}	0		0.4	V	
Output Differential Impedance	Z_{on}	80	100	120	Ω		

Notes:

Note 1) TD+/- are internally AC coupled with 100 Ω differential termination inside the module.

Note 2) Tx Fault and Rx LOS are open collector outputs, which should be pulled up with 4.7k to 10k Ω resistors on the host board. Pull up voltage between 2.0V and $V_{CC}+0.3V$.

Note 3) RD+/- outputs are internally AC coupled, and should be terminated with 100 Ω (differential) at the user SERDES.

● Optical Parameters($T_{OP} = 0$ to 70°C , $V_{CC} = 3.135$ to 3.465 Volts)

Parameter		Symbol	Min	Typ	Max	Unit	Ref.	
Transmitter								
Bit Rate		BR	9.9		11.3	Gb/s		
Optical Wavelength	TSBLXG60D-23	λ	1260	1270	1280	nm		
	TSBLXG60D-32		1320	1330	1340			
Average output power		Po	+1		+5	dBm		
Optical Extinction Ratio		ER	3.5			dB		
Spectral width		$\Delta\lambda$			1	nm		
Side Mode Suppression Ratio		SMSR	30			dB		
Optical Eye Mask			Compliant with IEEE802.3ae					
Receiver								
Bit Rate		BR	9.9		11.3	Gb/s		
Optical Wavelength	TSBLXG60D-23	λ	1320	1330	1340	nm		
	TSBLXG60D-32		1260	1270	1280			
Receiver Sensitivity		Sen			-22	dBm	1	
Maximum Input Power		P _{MAX}	-7			dBm		
LOS De-Assert		LOS _D			-23	dBm		
LOS Assert		LOS _A	-33			dBm		
LOS Hysteresis		LOS _H	0.5		4	dB		

Notes:

Note 1) Measured with a PRBS of $2^{31}-1$ at 1×10^{-12} BER and 3.5 dB extinction ratio.

● Pin Assignment

Diagram of Host Board Connector Block Pin Numbers and Name

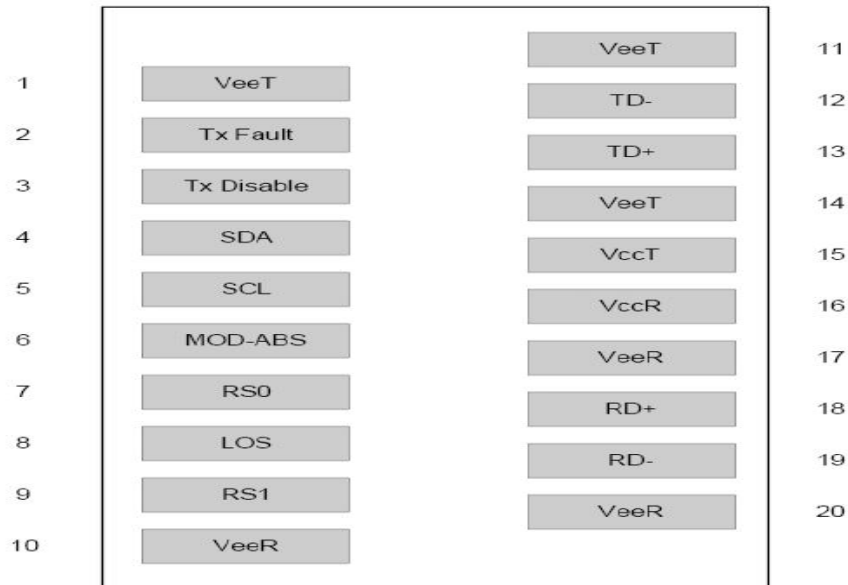

● Pin Function Definitions

PIN #	Name	Function	Notes
1	VeeT	Module transmitter ground	1
2	Tx Fault	Module transmitter fault	2
3	Tx Disable	Transmitter Disable; Turns off transmitter laser output	3
4	SDL	2 wire serial interface data input/output (SDA)	
5	SCL	2 wire serial interface clock input (SCL)	
6	MOD-ABS	Module Absent, connect to VeeR or VeeT in the module	2
7	RS0	Rate select0, optionally control SFP+ receiver. When high, input data rate >4.5Gb/s; when low, input data rate <=4.5Gb/s	
8	LOS	Receiver Loss of Signal Indication	4
9	RS1	Rate select0, optionally control SFP+ transmitter. When high, input data rate >4.5Gb/s; when low, input data rate <=4.5Gb/s	
10	VeeR	Module receiver ground	1
11	VeeR	Module receiver ground	1
12	RD-	Receiver inverted data out put	
13	RD+	Receiver non-inverted data out put	
14	VeeR	Module receiver ground	1
15	VccR	Module receiver 3.3V supply	
16	VccT	Module transmitter 3.3V supply	
17	VeeT	Module transmitter ground	1
18	TD+	Transmitter inverted data out put	
19	TD-	Transmitter non-inverted data out put	

20	VeeT	Module transmitter ground	1
----	------	---------------------------	---

Note 1) The module ground pins shall be isolated from the module case.

Note 2) This pin is an open collector/drain output pin and shall be pulled up with 4.7K-10Kohms to Host_Vcc on the host board.

Note 3) This pin shall be pulled up with 4.7K-10Kohms to VccT in the module.

Note 4) This pin is an open collector/drain output pin and shall be pulled up with 4.7K-10Kohms to Host_Vcc on the host board.

● SFP Module EEPROM Information and Management

The SFP modules implement the 2-wire serial communication protocol as defined in the SFP -8472. The serial ID information of the SFP modules and Digital Diagnostic Monitor parameters can be accessed through the I²C interface at address A0h and A2h. The memory is mapped in Table 1. Detailed ID information (A0h) is listed in Table 2. And the DDM specification at address A2h. For more details of the memory map and byte definitions, please refer to the SFF-8472, “Digital Diagnostic Monitoring Interface for Optical Transceivers”. The DDM parameters have been internally calibrated.

Table 1. Digital Diagnostic Memory Map (Specific Data Field Descriptions)

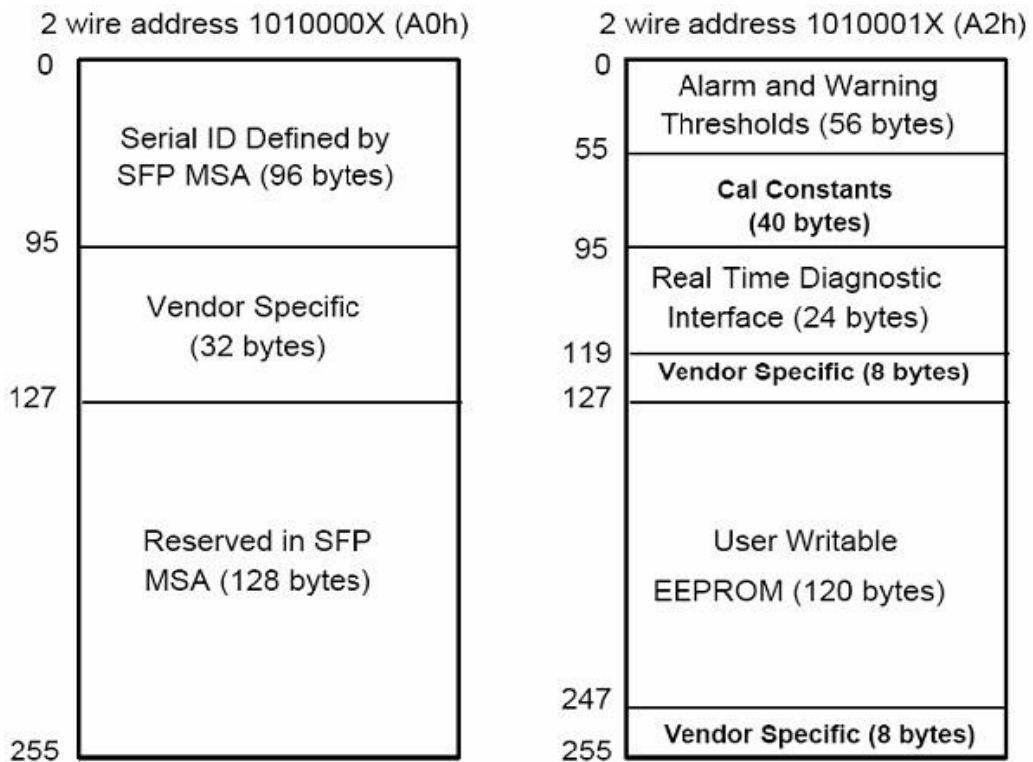

Table 2 - EEPROM Serial ID Memory Contents (A0h)

Data Address	Length (Byte)	Name of Length	Description and Contents
Base ID Fields			
0	1	Identifier	Type of Serial transceiver (03h=SFP)
1	1	Reserved	Extended identifier of type serial transceiver (04h)
2	1	Connector	Code of optical connector type (07=LC)
3-10	8	Transceiver	10G Base-LR
11	1	Encoding	64B/66B
12	1	BR, Nominal	Nominal baud rate, unit of 100Mbps
13-14	2	Reserved	(0000h)
15	1	Length(9um)	Link length supported for 9/125um fiber, units of 100m
16	1	Length(50um)	Link length supported for 50/125um fiber, units of 10m
17	1	Length(62.5um)	Link length supported for 62.5/125um fiber, units of 10m
18	1	Length(Copper)	Link length supported for copper, units of meters
19	1	Reserved	
20-35	16	Vendor Name	SFP vendor name: TIBTRONIX
36	1	Reserved	
37-39	3	Vendor OUI	SFP transceiver vendor OUI ID
40-55	16	Vendor PN	Part Number: "FT5960D-2733" or "FT5960D-3327" (ASCII)
56-59	4	Vendor rev	Revision level for part number
60-62	3	Reserved	
63	1	CCID	Least significant byte of sum of data in address 0-62
Extended ID Fields			
64-65	2	Option	Indicates which optical SFP signals are implemented (001Ah = LOS, TX_FAULT, TX_DISABLE all supported)
66	1	BR, max	Upper bit rate margin, units of %
67	1	BR, min	Lower bit rate margin, units of %
68-83	16	Vendor SN	Serial number (ASCII)
84-91	8	Date code	TIBTRONIX's Manufacturing date code
92-94	3	Reserved	
95	1	CCEX	Check code for the extended ID Fields (addresses 64 to 94)
Vendor Specific ID Fields			
96-127	32	Readable	TIBTRONIX specific date, read only
128-255	128	Reserved	Reserved for SFF-8079

● Digital Diagnostic Monitor Characteristics

Data Address	Parameter	Accuracy	Unit
96-97	Transceiver Internal Temperature	±3.0	°C
100-101	Laser Bias Current	±10	%
100-101	Tx Output Power	±3.0	dBm
100-101	Rx Input Power	±3.0	dBm
100-101	VCC3 Internal Supply Voltage	±3.0	%

● Regulatory Compliance

The TSBLXG60D-23 /32 complies with international Electromagnetic Compatibility (EMC) and international safety requirements and standards (see details in Table following).

Electrostatic Discharge (ESD) to the Electrical Pins	MIL-STD-883E Method 3015.7	Class 1(>1000 V)
Electrostatic Discharge (ESD) to the Single LC Receptacle	IEC 61000-4-2 GR-1089-CORE	Compatible with standards
Electromagnetic Interference (EMI)	FCC Part 15 Class B EN55022 Class B (CISPR 22B) VCCI Class B	Compatible with standards
Laser Eye Safety	FDA 21CFR 1040.10 and 1040.11 EN60950, EN (IEC) 60825-1,2	Compatible with Class 1 laser product.

● Recommended Circuit

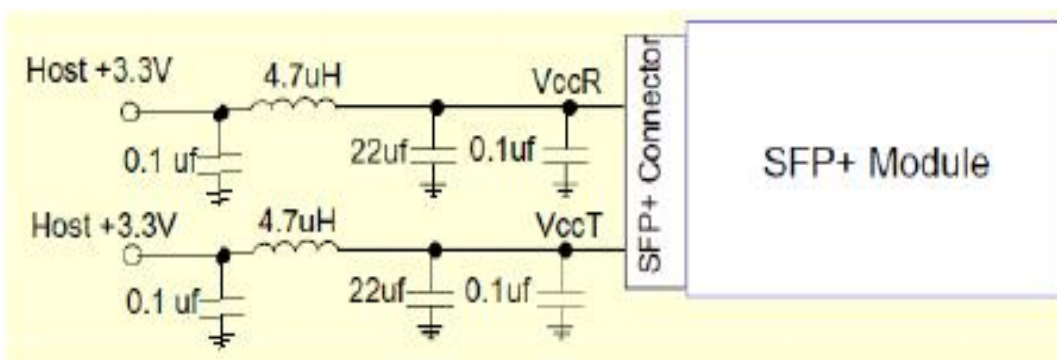

Recommended Host Board Power Supply Circuit

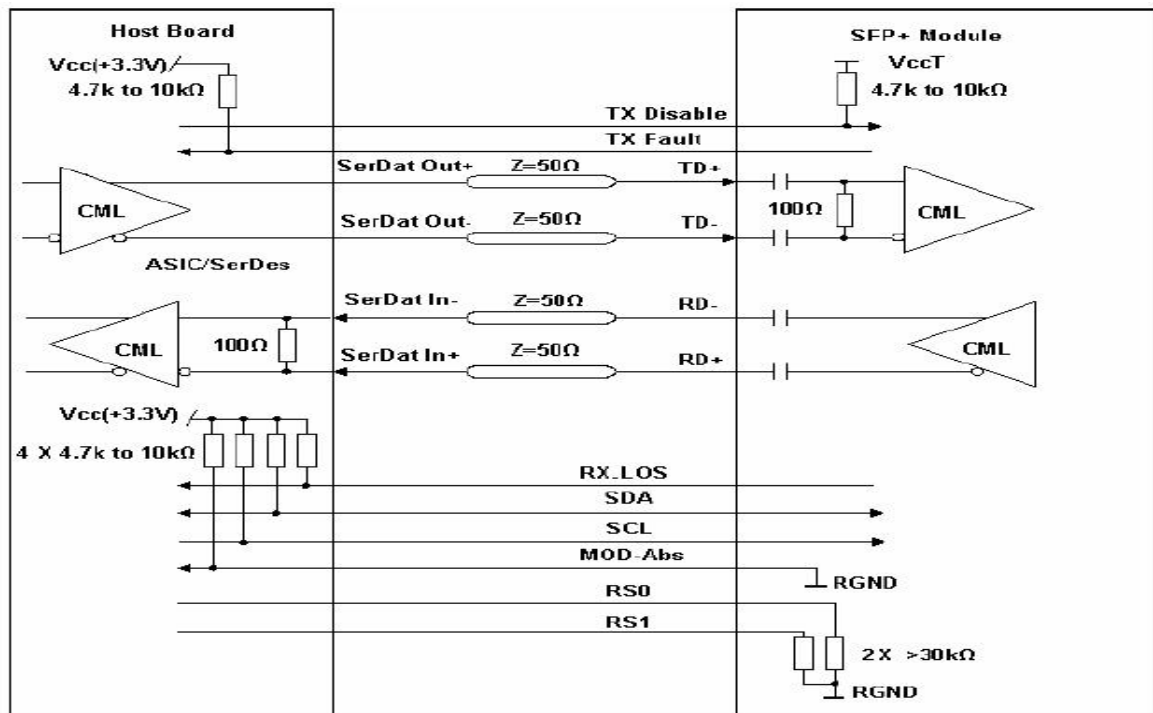

Recommended High-speed Interface Circuit

● Mechanical Dimensions

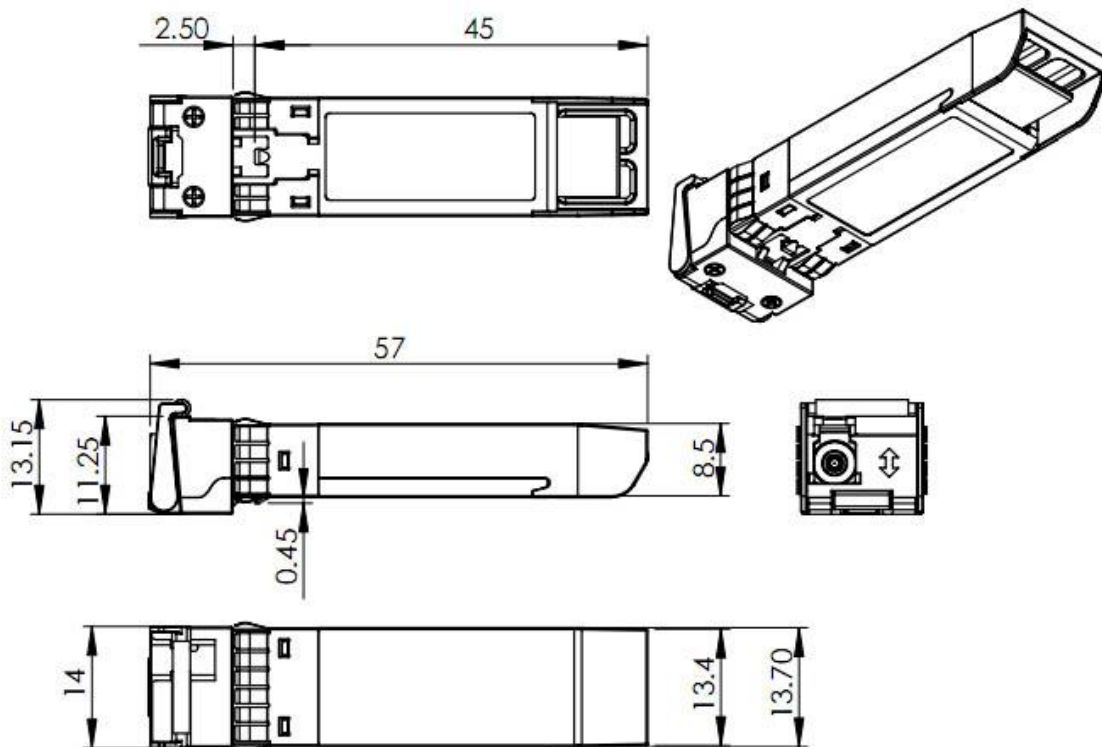

TIBTRONIX reserves the right to make changes to the products or information contained herein without notice. No liability is assumed as a result of their use or application. No rights under any patent accompany the sale of any such products or information.

Published by Shenzhen TIBTRONIX Technology Co., Ltd.

Copyright © TIBTRONIX

All Rights Reserved